

Contents	
Support beams and small beams	2
Enclosure beams	5
Small beams	6
Enclosure components-conduit elements	7
Connectors-angle brackets	8
Connectors	11
Feet	15
Feet, polyamide	18
Feet-end plates	20

## Support beams and small beams

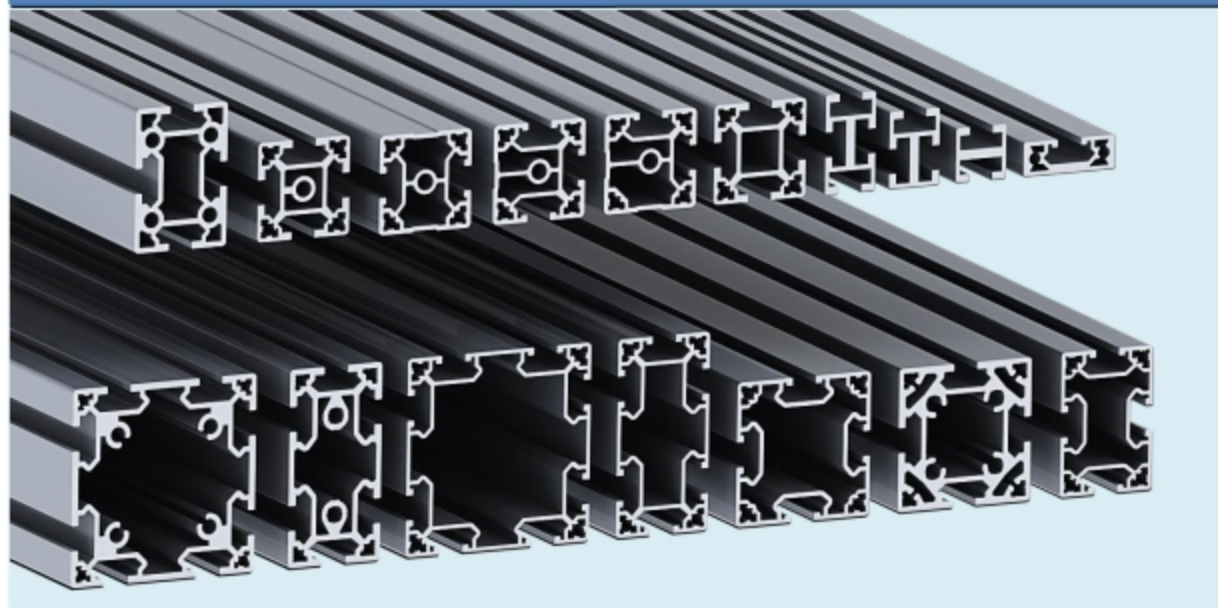

# Support beams

## FCBM 3X88

Beam 88 mm x 88 mm  
Heavyweight version  
Aluminium, anodized  
Length 3 mt

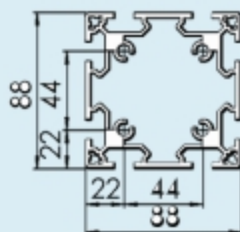

## FCBL 3X88

Beam 88 mm x 88 mm  
Lightweight version  
Aluminium, anodized  
Length 3 mt

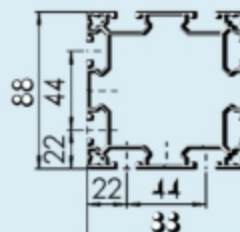

FCBE 88      End cap    Polyamide

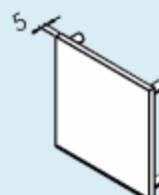

## FCBM 3X44X88

Beam 44 mm x 88 mm  
Heavyweight version  
Aluminium, anodized  
Length 3 mt

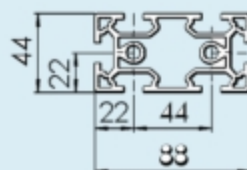

## FCBL 3X44X88

Beam 44 mm x 88 mm  
Lightweight version  
Aluminium, anodized  
Length 3 mt

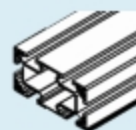
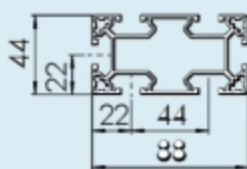

FCBE 44X88      End cap    Polyamide

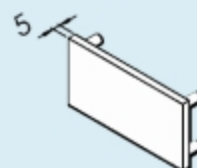

## FCBM 3X64

Beam 64 mm x 64 mm  
Heavyweight version  
Aluminium, anodized  
Length 3 mt

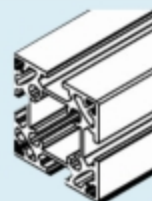
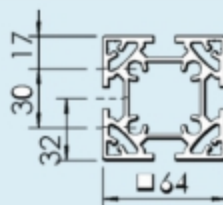

## FCBL 3X64

Beam 64 mm x 64 mm  
Lightweight version  
Aluminium, anodized  
Length 3 mt

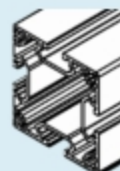
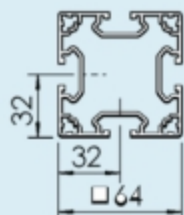

FCBE 64      End cap    Polyamide

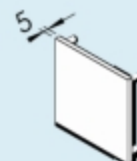

FC

# Support beams

## FCBM 3X44X64

Beam 44 mm x 64 mm  
Heavyweight version  
Aluminium, anodized  
Length 3 mt

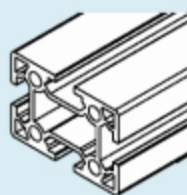
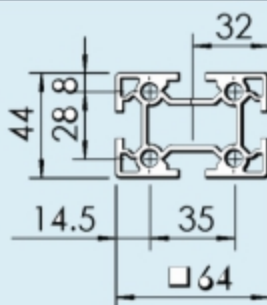

## FCBL 3X44X64

Beam 44 mm x 64 mm  
Lightweight version  
Aluminium, anodized  
Length 3 mt

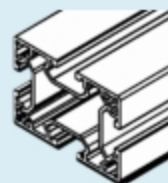
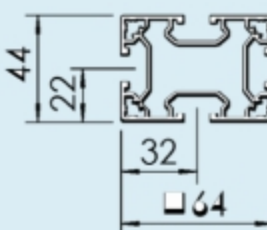

FCBE 44X64 End cap Polyamide

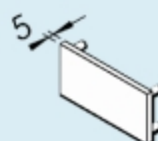

## FCBM 3X44

Beam 44 mm x 44 mm  
Heavyweight version  
Aluminium, anodized  
Length 3 mt

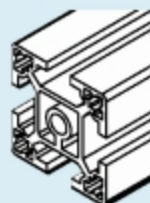
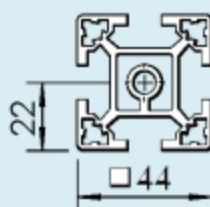

## FCBL 3X44

Beam 44 mm x 44 mm  
Lightweight version  
Aluminium, anodized  
Length 3 mt

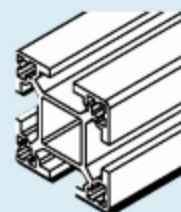
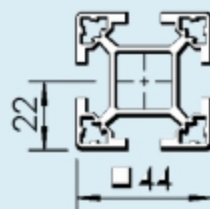

FCBE 44 End cap Polyamide

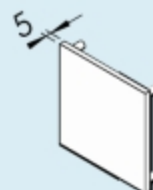

# Enclosure beams

## FCBL 3X44 T2

Beam 44 mm x 44 mm with  
two adjacent T-slots  
Lightweight version  
Aluminium, anodized  
Length 3 mt

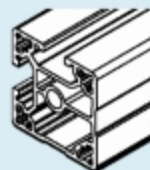
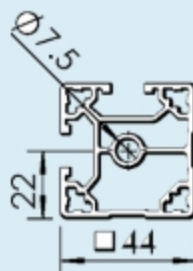

## FCBL 3X44 T2A

Beam 44 mm x 44 mm with  
two opposite T-slots  
Lightweight version  
Aluminium, anodized  
Length 3 mt

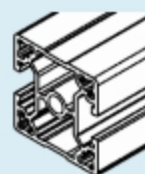
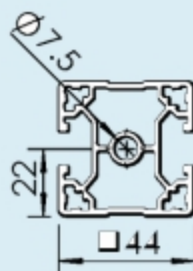

## FCBL 3X44 T3

Beam 44 mm x 44 mm with  
three T-slots  
Lightweight version  
Aluminium, anodized  
Length 3 mt

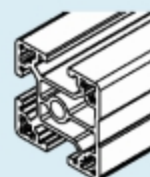
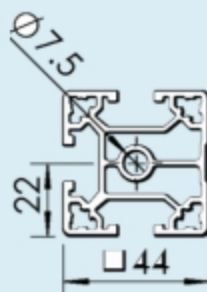

End cap for enclosure beams:  
see FCBE 44

# Small beams

## FCBL 3X15X44

Beam 15 mm x 44 mm  
Lightweight version  
Aluminium, anodized  
Length 3 mt

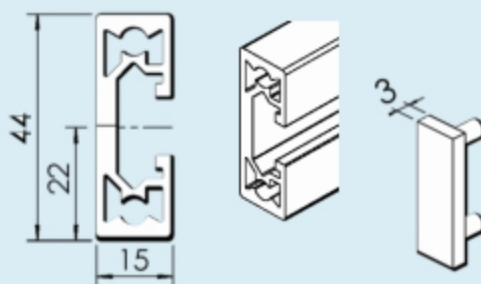

## FCBE 15X44

End cap, Polyamide

## FCBB 3X24X44

Beam 24 mm x 44 mm  
Aluminium, anodized  
Length 3 mt

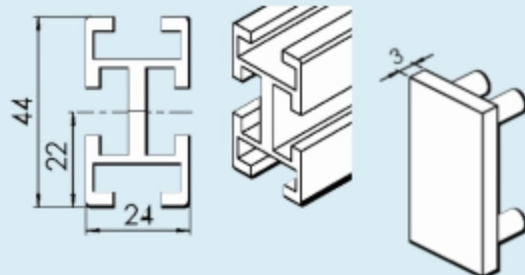

## FCBE 24X44

End cap, Polyamide

## FCBB 3X24X34

Beam 24 mm x 34 mm  
Aluminium, anodized  
Length 3 mt

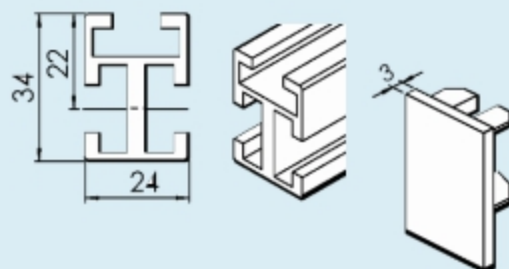

## FCBE 24X34

End cap, Polyamide

## FCBB 3X24

Beam 24 mm X 24 mm  
Aluminium, anodized  
Length 3mt

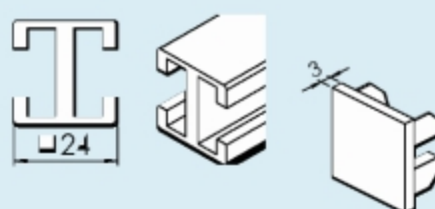

## FCBE 24

End cap, Polyamide

## FCAC 2

Cover strip  
Length 2 mt  
Aluminium, anodized

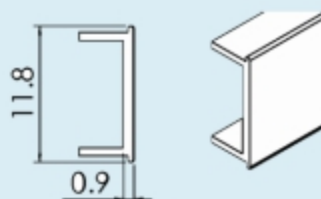

## FCAC 3 P

Cover strip  
Length 3 mt  
Polyvinyl chloride

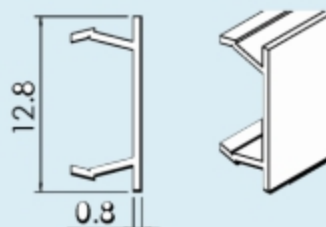

# Enclosure components-conduit elements

## FCCC 3X44

Cover for cable duct, 44 mm  
Aluminium, anodized  
Length 3mt

## FCCD 3X44

Cable duct, 44 mm X 44 mm  
Aluminium, anodized  
Length 3mt

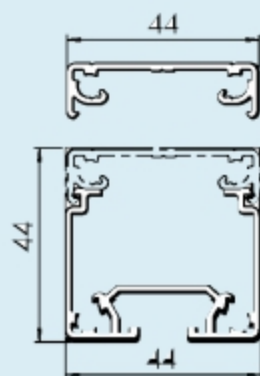

## FCCC 3X88

Cover for cable duct, 88 mm  
Aluminium, anodized  
Length 3mt

## FCCD 3X88

Cable duct, 88 mm X 88 mm  
Aluminium, anodized  
Length 3mt

## FCCD 3X44X88

Cable duct, 44 mm X 88 mm  
Aluminium, anodized  
Length 3mt

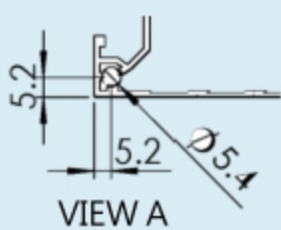
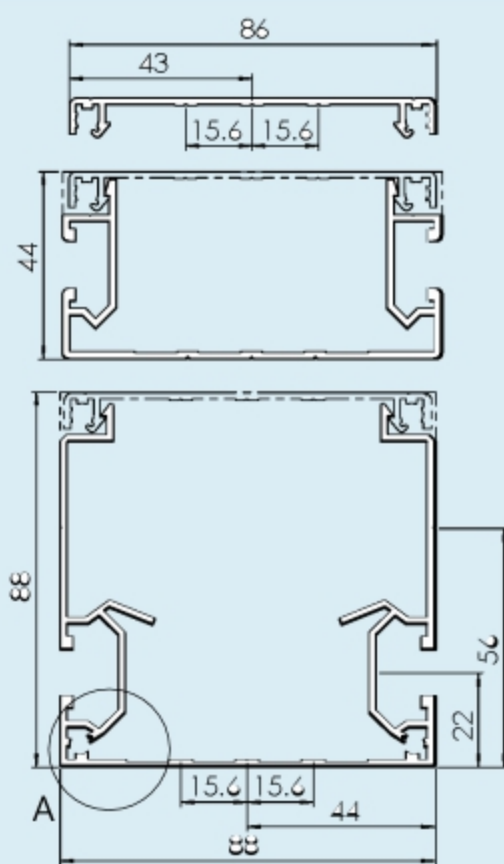

FC

# Connectors-angle brackets





# Angle brackets, die-cast

**FMFA 84 A** Angle bracket  
Aluminium, die-cast  
Mounting: M6S 8X16 (8)  
BRB 8.4X16 (8), FCAN 8 (8)

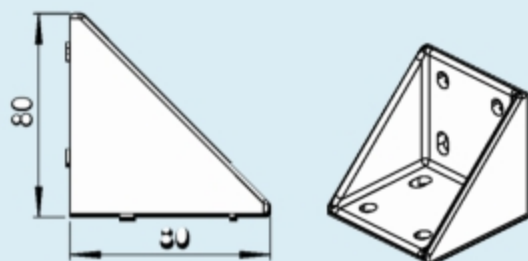

**FMFA 84 B** Angle bracket  
Aluminium, die-cast  
Mounting: M6S 8X16 (4)  
BRB 8.4X16 (4), FCAN 8 (4)



**FLFA 44 A** Angle bracket  
Aluminium, die-cast  
Mounting: M6S 8X16 (4)  
BRB 8.4X16 (4), FCAN 8 (4)

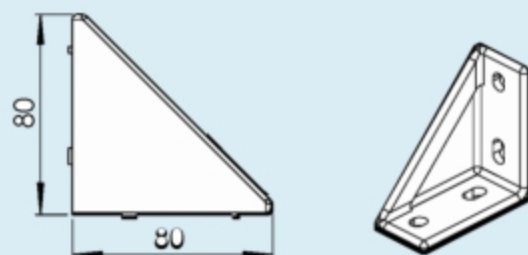

**FLFA 44 B** Angle bracket  
Aluminium, die-cast  
Mounting: M6S 8X16 (2)  
BRB 8.4X16 (2), FCAN 8 (2)

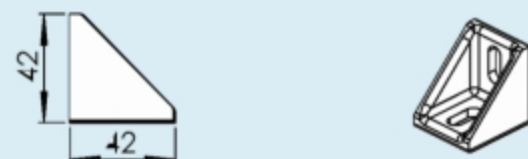

**FLFA 44 C** Angle bracket  
Aluminium, die-cast  
Mounting: M6S 8X16 (3)  
BRB 8.4X16 (3), FCAN 8 (3)



**FLFA 44 D** Angle bracket  
Aluminium, die-cast  
Mounting: M6S 8X16 (5)  
BRB 8.4X16 (5), FCAN 8 (5)

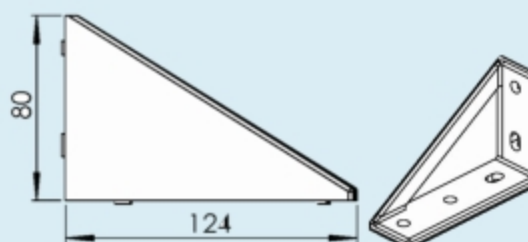

**FLFA 24** Angle bracket  
Aluminium, die-cast  
Mounting: M6S 6X14 (2)  
BRB 6.4X12 (2), FCAN 6 (2)

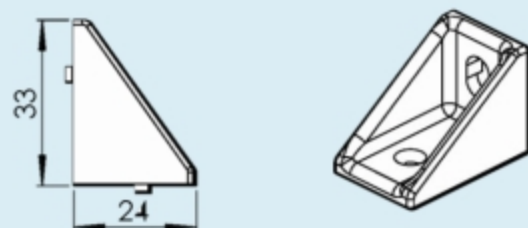

FC

# Angle brackets, extruded

**FMFA 84** Angle bracket  
Aluminium, die-cast  
Mounting: M6S 8X16 (6)  
BRB 8.4X16 (6), FCAN 8 (6)

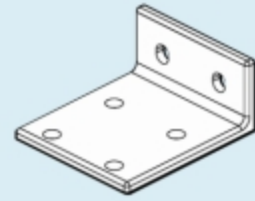

**FLFA 44** Angle bracket  
Aluminium, die-cast  
Mounting: M6S 8X16 (2)  
BRB 8.4X16 (2), FCAN 8 (2)

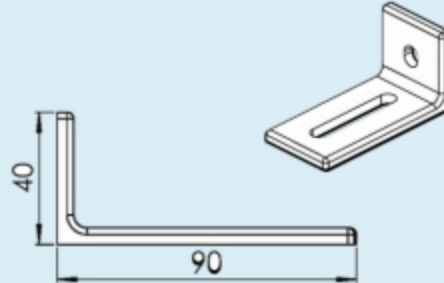

**FCFJ 44** Stay bracket, including  
reversible guide lugs Zinc,  
die-cast  
Mounting: MLC6S 8X14 (2),  
FCAN 8 (2), (beam side) or  
MLC6S 8'30 (2) (beam end)

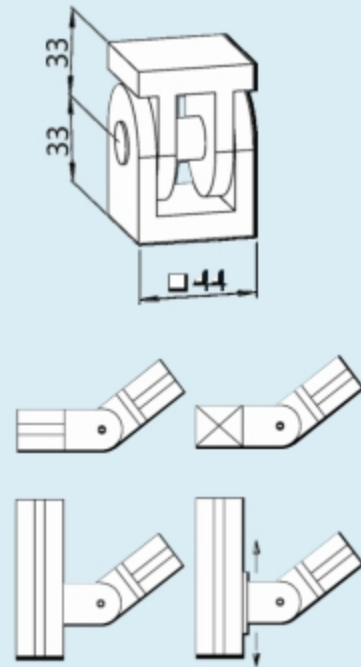

**FCFJ 44 F** Stay bracket, including  
reversible guide lugs Zinc,  
die-cast  
Mounting: MLC6S 8X14 (2),  
FCAN 8 (2), (beam side) or  
MLC6S 8'30 (2) (beam end)

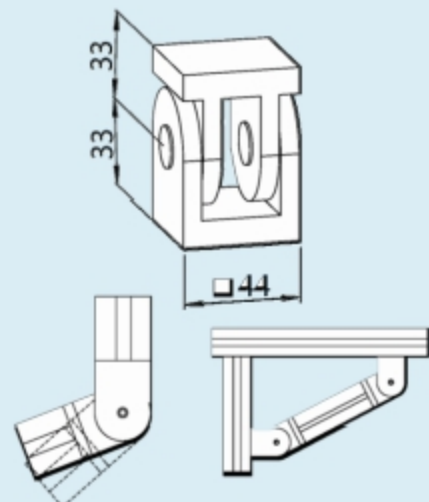

# Connectors-slot fasteners

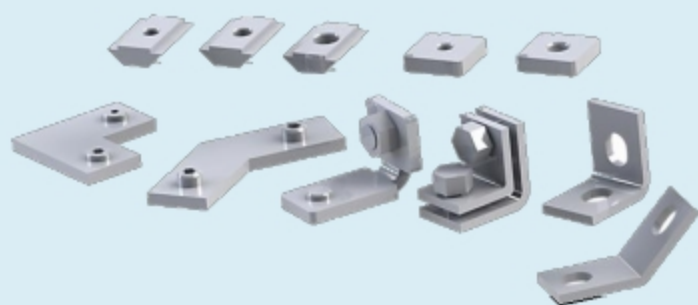

# Slot nuts and nut profile

FCAN 8 Slot nut, M8 thread  
Steel, zinc-chromated

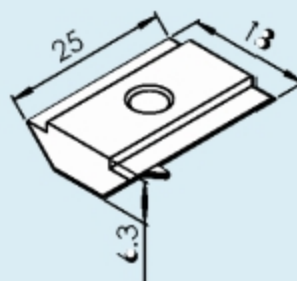

FCAN 6 Slot nut, M6 thread  
Steel, zinc-chromated

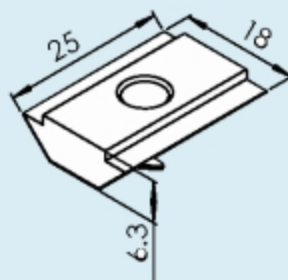

FCAN 5 Slot nut, M5 thread  
Steel, zinc-chromated

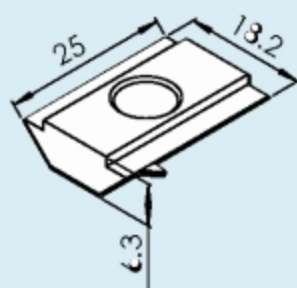

FLAQ 8 Square nut, M8 thread  
Steel, electro-zinc-plated

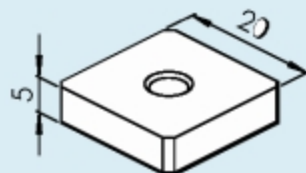

FLAQ 6 Square nut, M6 thread  
Steel, electro-zinc-plated

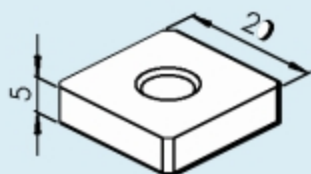

FLAR 6 Rhombus nut, M6 thread

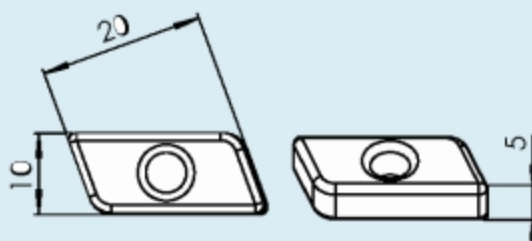

# Connecting strips

## FLCJ 5X140

Connecting strip with M8 set screws  
Length 140 mm  
Steel, electro-zinc-plated

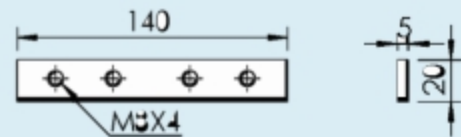

## FLCJ 5X76

Connecting strip, M8 thread  
Length 76 mm  
Steel, electro-zinc-plated

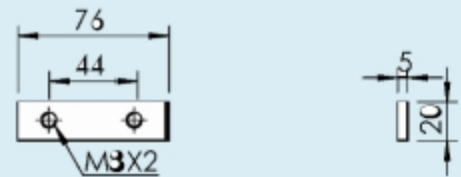

## FSCJ 6X130

Connecting strip, M8 thread  
Length 130 mm  
Steel, electro-zinc-plated

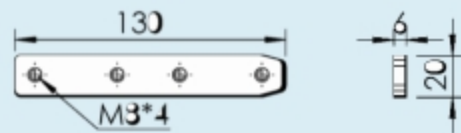

## FSCJ 6X160

Connecting strip, M8 thread  
Length 160 mm  
Steel, electro-zinc-plated

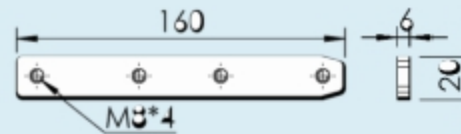

## FLCJ 6X130

Connecting strip, M8 thread  
Length 130 mm  
Steel, electro-zinc-plated

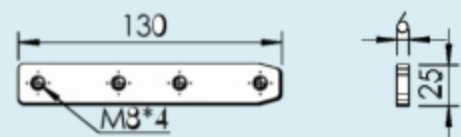

## FLCJ 6X140

Connecting strip, M8 thread  
Length 140 mm  
Stainless steel

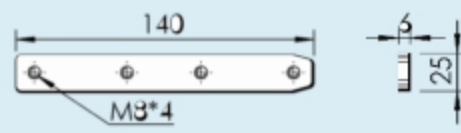

## FLCJ 6X160

Connecting strip, M8 thread  
Length 140 mm  
Stainless steel

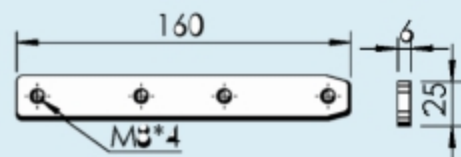

## FCFP 75

Parallel connector assembly  
for connecting beams T-slot  
to T-slot  
Length 75 mm  
Aluminium, anodized

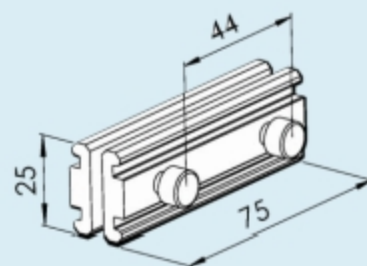

# Connectors-small fittings

## FMRX 20

Inner fitting 90°

Including T-Bolt, nut,  
set screw

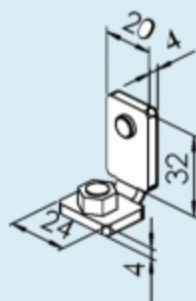

## FMRY 20

Inner fitting 90°, double

Including screws

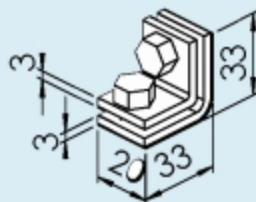

## FMRY 20A

Inner fitting 90°

Mounting: M6S 8X14 (2)

BRB 8.4X16 (2)

FCAN 8 (2)



## FMRY 20X45A

Inner fitting 45°

Mounting:

M6S 8X14 (2)

BRB 8.4X16 (2)

FCAN 8 (2)

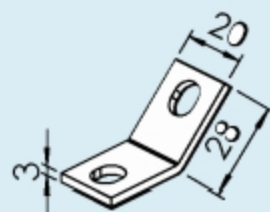

## FMRW 20

Corner fitting 90°

Including set screws

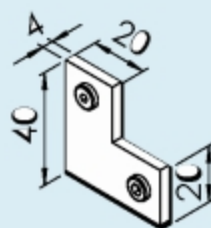

## FMRW 20X45

Corner fitting 45°

Including set screws

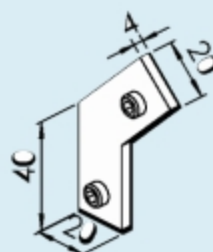

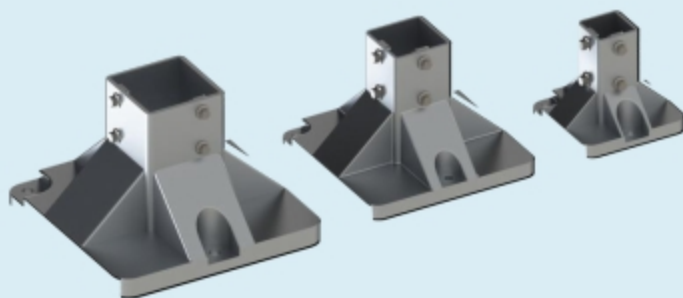

# Feet

Feet  
Including fastener kit  
Aluminium, die-cast

## FCFF 88X260 A

Foot for beam FCBM/FCML..X88  
Max. bending moment 1500 Nm

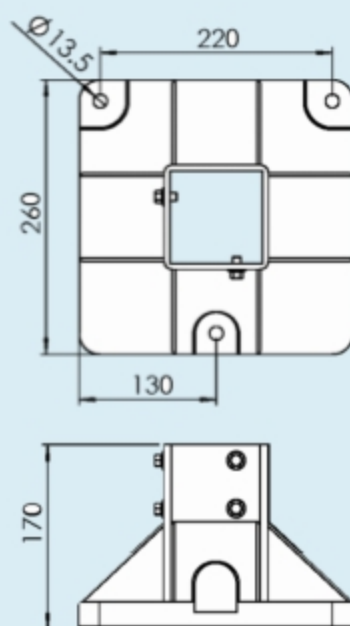

## FCFF 64X210 A

Foot for beam FCBM/FCML..X64  
Max. bending moment 750 Nm

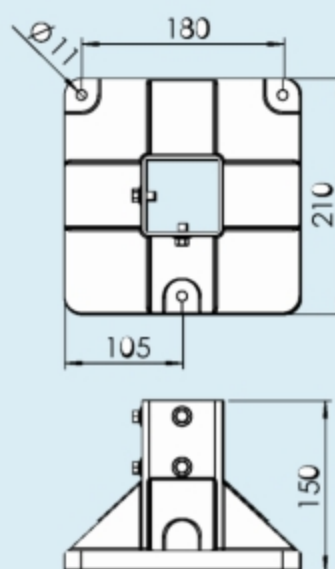

## FCFF 44X130 A

Foot for beam FCBM/FCML..X44  
Max. bending moment 250 Nm

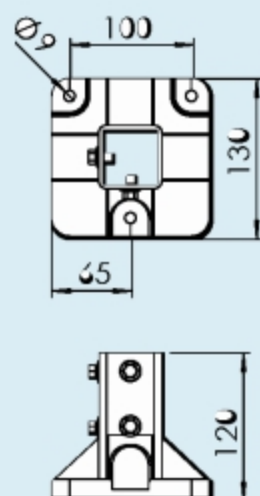



# Feet

## FCFB 88 F

Foot plate for beam

FCBM/FCBL..X88

Aluminium, anodized

Mounting: MF6S 8X30 (4)

or MF6S 6X30 (4)

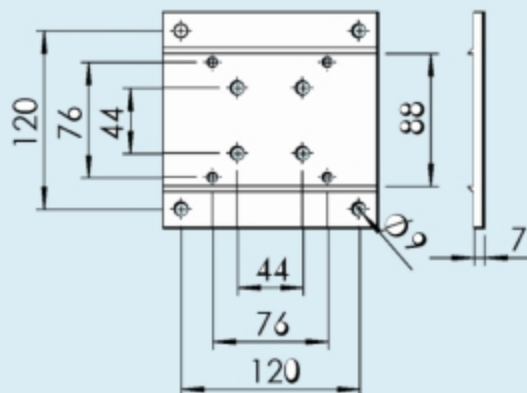

## FCFB 44X64 A

Foot plate for beam

FCBM 44X64 mm

Aluminium, anodized

Mounting: M6S 8X18 (2)

BRB 8.4X16 (2), FCAN 8 (2)+

MF6S 8X30 (4).

Cannot be used with FCBL beams

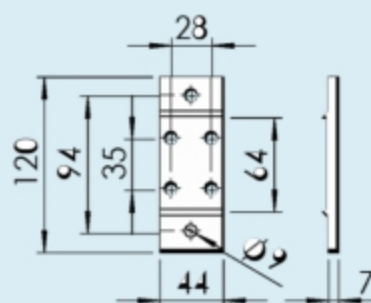

Adjustable foot

Including nut

## FCFS 12X56

M12 thread

Mounting: FCFE..M12

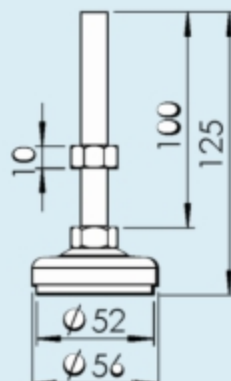

Guide rollers

Including fastener kit

Steel, electro-zinc-plated

Mounting: FCAN 8 or FCFE ..

M12

Max. vertical load 600 N

FCAG 80 A Guide roller

FCAG 80 BA Guide roller with  
multistop brake

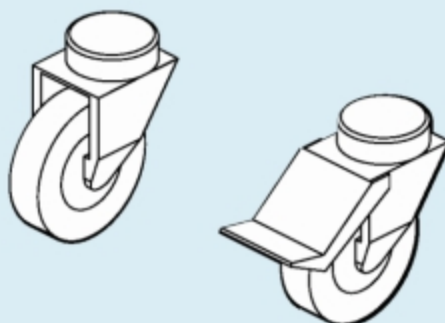

FC

## Feet for 64 mm beam

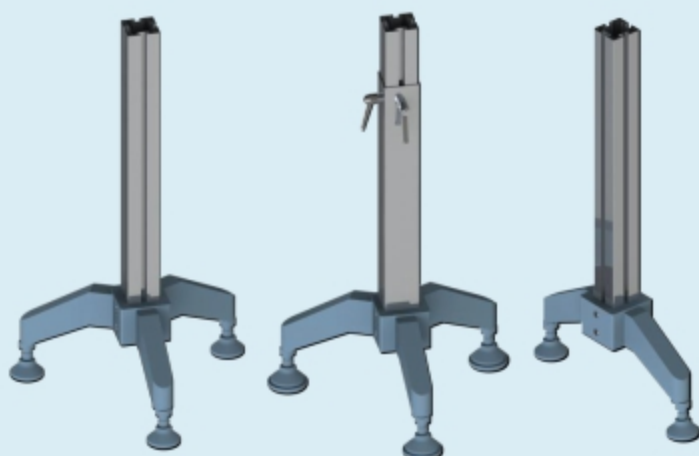

# Feet, polyamide, for 64 mm beam

## FEFG 64 T

Three-point foot for FC..64 beam

D=64 mm

Incl. screws and clamps

Polyamide, glass-fibre reinforced

Max. vertical load 800 N

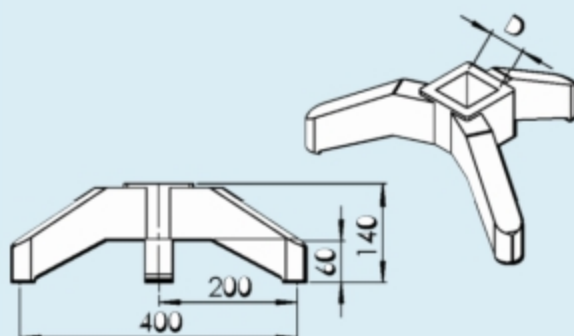

## FEFG 70 T

Three-point foot for FEFU 500

D=70 mm

Incl. screws and clamps

Polyamide, glass-fibre reinforced

Max. vertical load 800 N

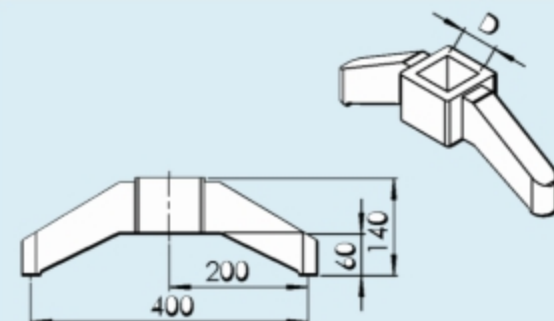

## FEFG 64 D

Two-point foot for FC..64

D=64 mm

Incl. screws and clamps

Polyamide, glass-fibre reinforced

Max. vertical load 800 N

## FLFS 20P

Adjusting foot for FEFG 64/70 T/D

Polyamide glass-fibre reinforced

With ball joint and M20 locking nut

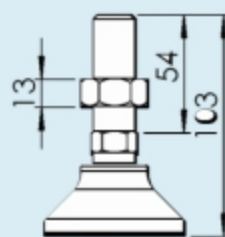

## FLFJ 69

Vibration absorber

For FLFS 20 P

Thermoplastic polyester

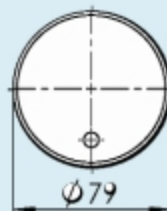

## FEFU 500

Square section tube height adjustment assembly for FEFG 70 T

Including locking levers

Length 500 mm

Aluminium, anodized

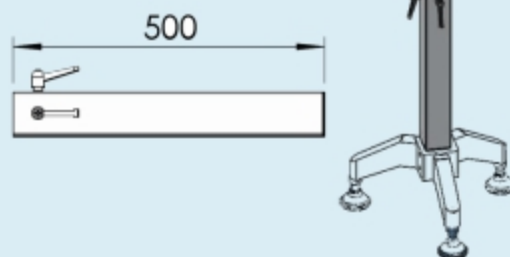

FC

# Feet-end plates

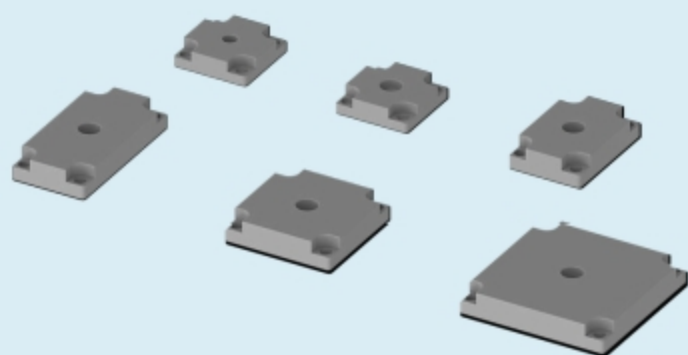

# End plates

## FCFE 44 M8

End plate for beam  
FCBL...X44, M12 thread  
Zinc, die-cast Mounting:  
MC6S 6X30 (4)

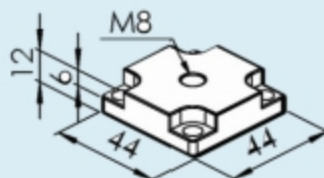

## FCFE 44 M12

End plate for beam  
FCBL...X44, M8 thread  
Zinc, die-cast Mounting:  
MC6S 6X30 (4)

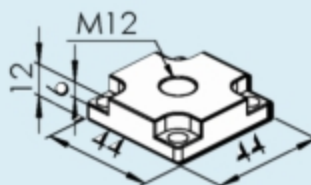

## FCFE 44X64 M12 A

End plate for beam  
FCBL/FCBM...X44X64,  
M12 thread  
Zinc, die-cast Mounting:  
MC6S 6X30 (4)

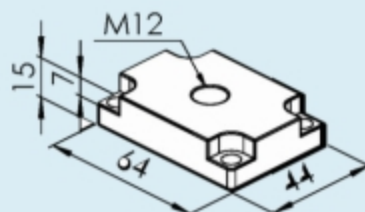

## FCFE 44X88 M12 A

End plate for beam  
FCBL/FCBM...X44X64,  
M12 thread  
Zinc, die-cast Mounting:  
MC6S 6X30 (4)

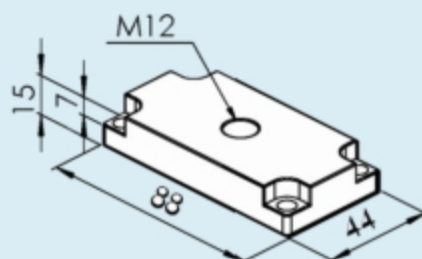

## FCFE 64 M12 A

End plate for beam  
FCBL/FCBM...X64,  
M12 thread  
Zinc, die-cast Mounting:  
MC6S 6X30 (4)

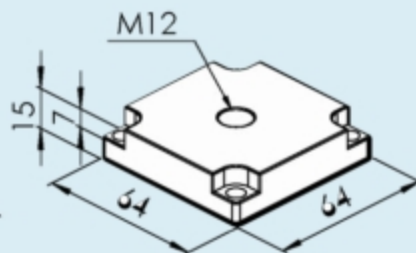

## FCFE 88 M12 A

End plate for beam  
FCBL/FCBM...X88,  
M12 thread  
Zinc, die-cast Mounting:  
MC6S 6X30 (4)

